

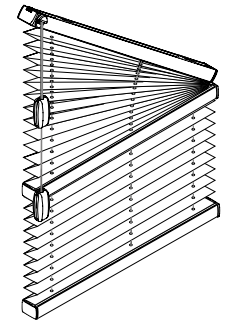

# F Slope 1, F Slope 2, FD Slope 3, FD Slope 4

## Montage- und Bedienanleitung

Assembly and operating instructions  
Notice de montage et mode d'emploi



0404604644473



## Achtung

Attention – Attention

Kinder können sich in den Schlingen von Schnüren, Ketten oder Gurten zur Bedienung von Sicht- und Sonnenschutzeinrichtungen verfangen oder sich Schnüre um den Hals wickeln und sich unter Umständen dadurch strangulieren. Schnüre, Ketten und Gurte sind außer Reichweite von Kindern zu halten, um Verwicklungen und Strangulierungen zu vermeiden. Betten, Kinderbetten und Möbel sind entfernt von Bedienungen für Sicht- und Sonnenschutzeinrichtungen aufzustellen.

Children can get caught in the loops of cords, chains or straps that operate window coverings or they can wrap cords around their necks and strangle thereby. Keep cords, chains and straps out of reach of children to avoid entanglement and strangulation. Move beds, cots and furniture away from window covering operations.

Les enfants peuvent se prendre dans cordons, chaînettes ou courroies qui actionnent les stores de protection solaire et visuelle ou ils peuvent enrouler les cordons autour leur cou et ainsi s'étouffer. Maintenez les cordons, chaînettes et courroies hors de portée des enfants pour éviter de s'étouffer ou de s'emmêler. Placez les lits, berceaux et meubles à l'écart des manipulations des stores de protection solaire et visuelle.

entspricht EN 13120  
according to EN 13120 – selon EN 13120

03 / 2021

technische Änderungen bleiben  
vorbehalten

subject to technical change  
sous réserve de modifications techniques

## Child Safety

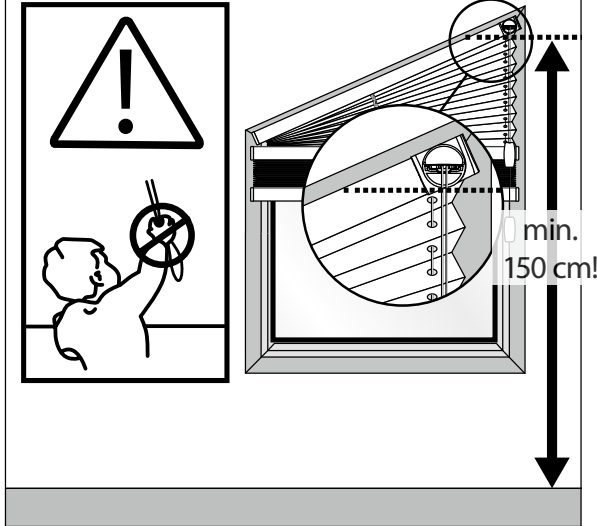

# A Montage

Fixation – Montage

→ **Bitte nur beiliegende Schrauben verwenden!**

Please use only the enclosed screws! – Veuillez utiliser seulement les vis jointes!

## DECKENCLIP FÜR F SLOPE 1, F SLOPE 2

CEILING CLIP FOR F SLOPE 1, F SLOPE 2 –  
CLIP PLAFOND POUR F SLOPE 1, F SLOPE 2

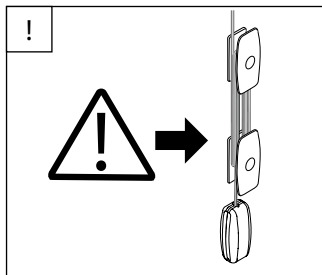
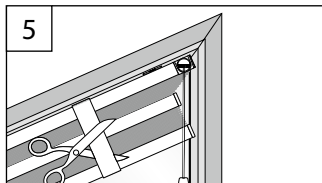
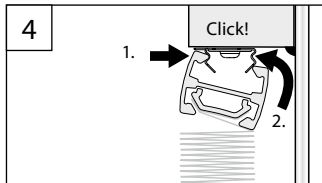
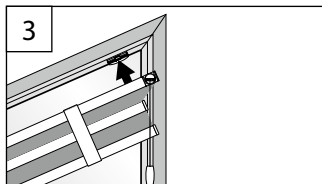
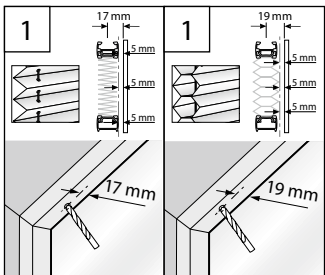
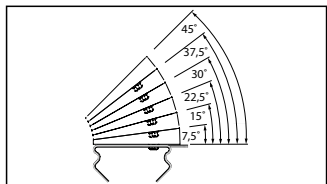
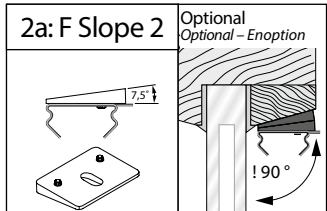
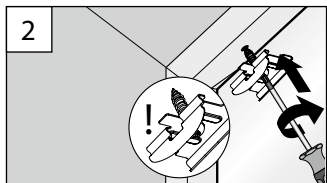
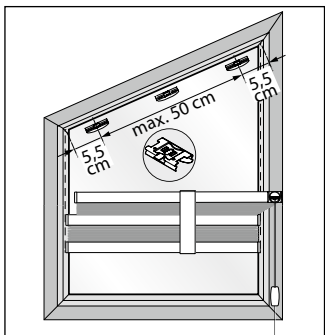
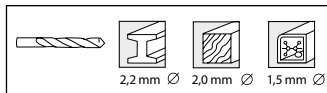

1

## WANDWINKEL FÜR F SLOPE 1, F SLOPE 2

WALL FIXING BRACKET FOR F SLOPE 1, F SLOPE 2 –  
SUPPORT MURAL POUR F SLOPE 1, F SLOPE 2

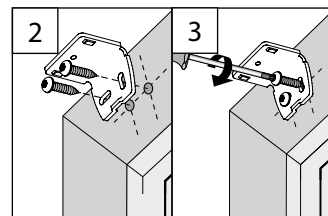
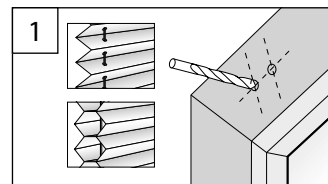
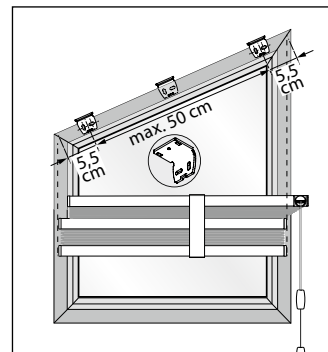

2

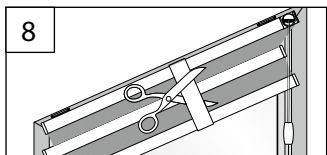
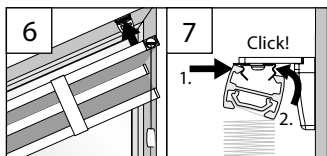
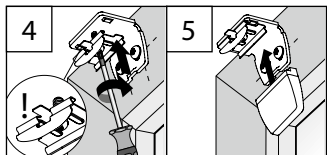

**DECKENCLIP FÜR FD SLOPE 3**  
 CEILING CLIP FOR FD SLOPE 3  
 – CLIP PLAFOND POUR FD SLOPE 3

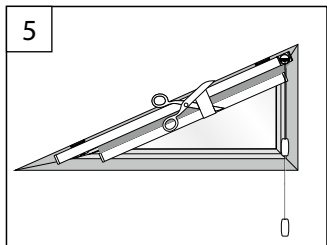
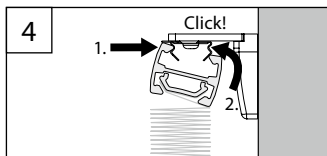
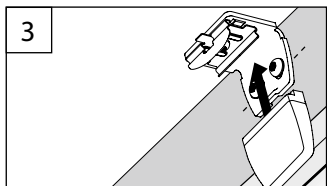
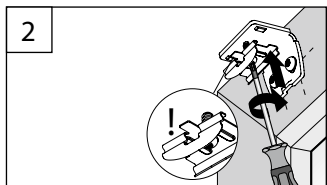
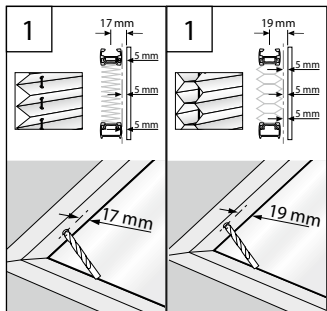
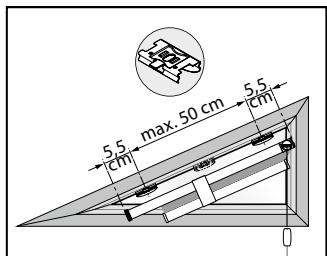

**WANDWINKEL FÜR FD SLOPE 3**  
 WALL FIXING BRACKET FOR FD SLOPE 3 –  
 SUPPORT MURAL POUR FD SLOPE 3

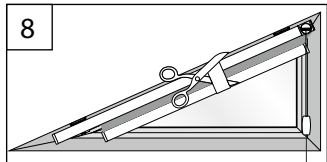
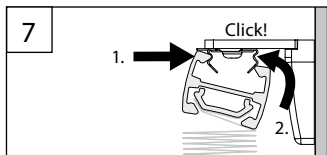
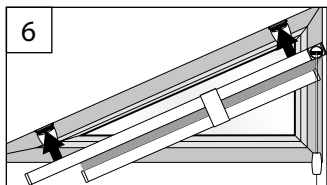
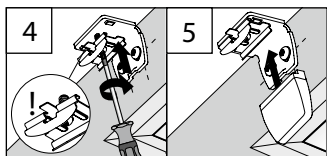
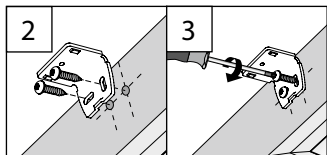
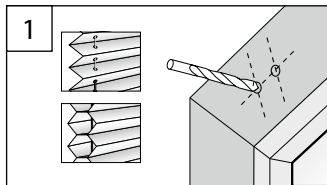
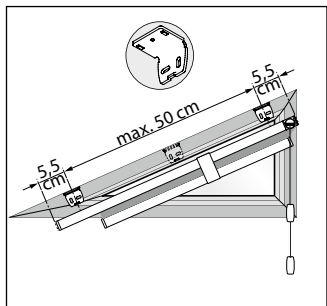

## B Demontage

Dismantling – Démontage

### DECKENCLIP FÜR F SLOPE 1, F SLOPE 2

CEILING CLIP FOR F SLOPE 1, F SLOPE 2 –  
CLIP PLAFOND POUR F SLOPE 1, F SLOPE 2

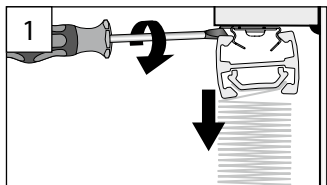

### DECKENCLIP FÜR FD SLOPE 3

CEILING CLIP FOR FD SLOPE 3 –  
CLIP PLAFOND POUR FD SLOPE 3

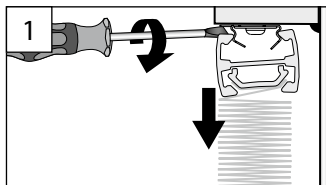

### WANDWINKEL FÜR F SLOPE 1, F SLOPE 2

WALL FIXING BRACKET FOR F SLOPE 1, F SLOPE 2 –  
SUPPORT MURAL POUR F SLOPE 1, F SLOPE 2

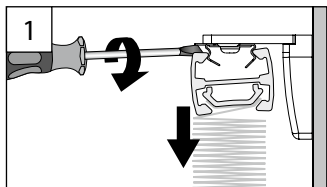

### WANDWINKEL FÜR FD SLOPE 3

WALL FIXING BRACKET FOR FD SLOPE 3 –  
SUPPORT MURAL POUR FD SLOPE 3

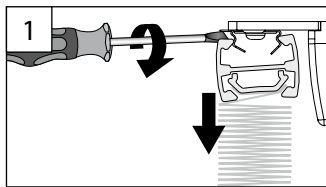

5

## C Bedienung

Operation – Manipulation

### F SLOPE 1

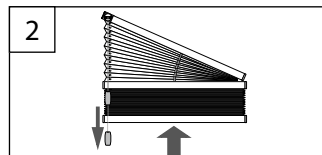
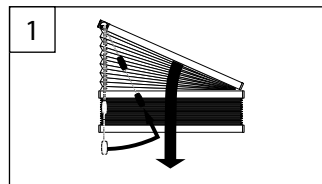

### F SLOPE 2

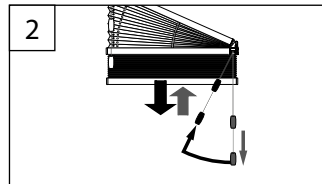
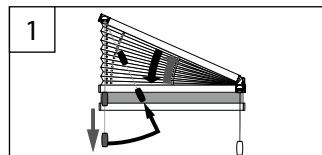

### FD SLOPE 3

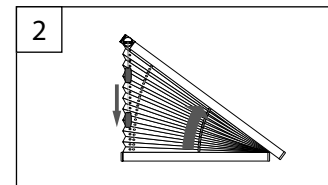
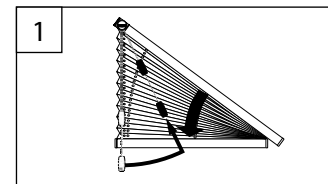

6